

BAIMEN GROUP



无锡市北奕挖掘机配件制造厂
WUXI BEIYI EXCAVATOR PARTS FACTORY

地址/Address: 无锡市洛社镇双庙工业园A区
Shuangmiao Tndustry ParkA, Luoshe Town, Huishan District, Wuxi
传真/Fax: 0510-85167422
网址/Website: www.by997.com
邮箱/Email: wxby997@163.com



Multi-function Hercules shear

多功能大力神剪

使用说明书

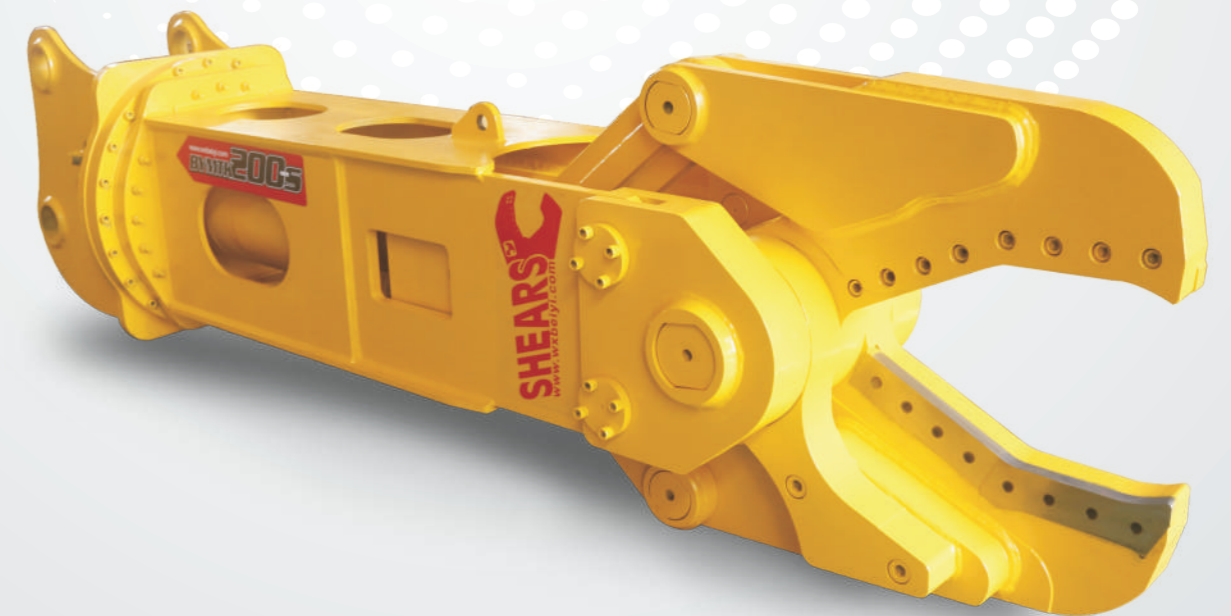

目录Directory

| | |
|--|-------|
| 引言 Introduction | 1-2 |
| 规格及适用对象 Specification & Suitable Equipment | 3-4 |
| 综述 General Information | 5-8 |
| 操作守则 Operation | 9-11 |
| 操作警告 Caution | 12 |
| 安装说明 Installation | 13-15 |
| 检测及保养 Detection and Maintenance | 16-17 |



引言

- 非常感谢您购买北奕液压特殊装备。
- 我们的产品在各种建筑工地或回收场所，如剪断钢筋、拆卸报废车等，发挥着十分重要的作用。
- 推出本手册的目的是为了让您了解我公司的产品及其相关的安全操作的内容。本手册内容包括安全指南，维护保养，正确操作方法及技术数据等，这些对于安装操作及保养我公司的产品都是有帮助的。我公司产品适用各种轮式或履带式挖掘机等。
- 北奕公司采用先进的技术与精湛的工艺生产出许多不同功能的液压装置。例如，鹰嘴剪由较少的部件组成，结构简单，维护性极好。
- 我们的产品可靠性、耐用性极好，工作无障碍，定能在作业中发挥优异的工作性能，给您带来丰厚的回报。
- 尽管我们对自己的产品引以为豪，如果您不习惯于正确的操作我们的产品，那么将会带来意想不到的事故或损害，结果是工作的性能及功效大打折扣。因此，您必须仔细阅读我们的产品说明书，彻底的理解其中的内容，实时保证操作正确完好，并定期对产品进行维护保养。
- 首先为了您的安全，请首先阅读和学习本手册。手册中向您介绍了可能会发生的危险及如何避免危险的发生。如果您对本产品有任何问题，请与我公司或我们的代理商联系。若您想更换任何部件，请您务必使用北奕公司正品。
- 我们衷心祝愿我们的产品能给您带来丰厚的回报，并再次感谢您购买我们的产品。

Introduction

- Thank you for purchasing our products ; Crusher, Shear and Beiyi processor.
- Our company has developed a state-of-the-art hydraulic attachments since 1989, and our products play a major role in quarries and various construction sites, such as building disassembly, breaking up roads, housing land development, sewage system and so on.
- This manual has come out for your understanding of products and its safe operation. It contains safety guide, maintenance information, proper operating method, technical data, and etc., which are useful in installing, operating and maintaining our products with various kinds of wheel or track type excavators, back-hoes loaders.
- Beiyi has manufactured various attachments with precious and updated technology and well skilled workmanship, for example, hydraulic crushers are made up of a small number of parts with simple structure and excellent maintenance.
- Excellent durability, reliability, and trouble-free operation resulted from the above features, and they give you much more profits and good performance for your job.
- Although we make our products that we can be proud of, if you are not accustomed to operating properly, there may be unexpected accidents or disorders, onsequently the performance and efficiency of the products will be dropped down sharply. So you must read this manual carefully and thoroughly to keep operating well and the products need to be maintained periodically and operated correctly for good condition.
- First of all, you ought to read and study this manual for your safety. It will inform you of hazards and how to avoid them. If you have questions about the products and manual, please contact us or our agents. Every time you want to replce any of the spare parts, please make sure you use Beiyi genuine parts. We do not guarantee any damages, disorders, and injuries caused by your mistake.
- We wish you get more profits with our products and thank you again for your purchasing.

规格及适用设备 Specification & Suitable Equipment

适用像及范围

| 项目 | 图片 | 单位 | BYCS60RT | BYCS250RT | BYCS350RT |
|-----|--|----|----------|-----------|-----------|
| 圆钢 |  | mm | Φ 40 | Φ 50 | Φ 60 |
| 工字钢 |  | mm | 150X80 | 500X200 | 700X300 |
| 管道 |  | mm | Φ 80*4 | Φ 150*6 | Φ 200*8 |
| 钢板 |  | mm | 20X100 | 30X150 | 50X200 |
| 三角铁 |  | mm | 50X50X6 | 100X100X8 | 150X150X8 |

非剪切范围 Material containing alloy material.

| | | | |
|--|---------------------|---------------------------|--|
| 含有合金材质的材料 Material containing alloy material. | 弹簧钢 Spring steel | 汽车传动轴 Car drive shaft. | 强硬钢及超规格范围的钢材 Strong steel and ultra - specification range of steel. |
| 以上材料为本鹰嘴剪不能剪的范围，如强行剪切导致设备损坏我司不予以三包！ The above material is the range of the hydraulic shear cant beak ,If the equipment is damaged by forced cutting, our company will not give warrenty | | | |

性能参数/Performance Parameter

| 型号 Module | 总重量 Total Weight kg | 全长 Total Length mm | 最大开口宽度 Max opening width mm | 最大使用油压 Max oil pressure Mpa | 开口深度 Opening depth mm | 适配挖机重量 Hydraulic excavator T |
|--------------|---------------------------|--------------------------|-----------------------------------|-----------------------------------|-----------------------------|------------------------------------|
| BY-MTK150S | 1500 | 2600 | 400 | 32 | 370 | 12-15 |
| BY-MTK200S | 2100 | 2690 | 520 | 32 | 420 | 15-20 |
| BY-MTK250S | 2600 | 3135 | 550 | 32 | 600 | 20-30 |
| BY-MTK300S | 2700 | 3184 | 860 | 32 | 486.5 | 20-30 |

综述 General Information

1.编号Serial Number

打在盖板上的编号是修理机器和定制配件的重要依据。我们对自己产品的质量严格把控，当我们产品出故障时，这个编号必须给我们的工厂一带来修理及维护。因此，您必须记住一些特殊装备的号码，它们一般在我们产品主体的主体中央位置或是产品的一侧。

The seial number stamped on the metal name plate is important for repairing and ordering spare parts. We make our products very precautious under stern quality control, when the products run out of order, the number must be presented to our shop for maintenance or repairing. Therefore, you have to keep in mind the serial number for the specific product, which is usually located on the center of the main body or the side of the equipment.

2.服装Clothing

如果您穿着不合适的服装可能会有危险。宽松的衣服可能会被机器挂住。另外穿着防护服也适合工作。例如，您必须戴安全帽，穿安全鞋，穿安全服，工装裤，工业手套等。请不要打领带或戴围巾，也不要留很长的头发。

You can be injured if you do not wear proper clothing. Loose clothing can get caught in the machine. Also wear protective clothing to suit the job. For example, you have to wear a safety space helmet, safety shoes, safety glasses, well-fitting overalls, ear-protectors and industrial gloves. Please, do not wear a necktie or scarf and do not keep long hair restrained.

3.起吊设备Lifting Equipment

不正确的使用起吊设备会引起受伤。您应该知道如何使用起吊设备并且考虑它的承载能力是否可以适用您的设备。

确认起吊设备完好无缺的适用工作并且符合当地法规。

The use of improper lifting equipment can cause injury. You should know how to use the equipment, and the equipment should be strong enough for your job.

Make sure that lifting equipment is in good condition, suitable for the job and complies with all local regulations.

4.安全守则Safety

这个手册就是您安全操作并且保养您的北奕产品的指南。安装操作或保养产品之前，您必须仔细阅读本手册并且与产品一起保留。我们公司产品被广泛使用于剪断钢筋、拆卸报废车等艰苦环境中。只要您正确使用，您一定会成为工程机械中一个有技术的人。

知道您能使用工程搬运车您才能安装或使用此设备。请不要急忙工作，先花费点时间认真学习一下安全知识。液压油的操作也是危险的。在连接或断开液压软管之前，停止设备工作并且释放软管压力。当您离开设备的时候请确保设备的引擎关掉并且设备降低。

This manual is a guide to the safe operation and maintenance of your Beiyi products. Before installing, operating or maintenances of the products, you must read this manual carefully, and keep the manual with the Beiyi attachments. Beiyi products are oversized boulders, demolishing reinforced structures, pulverizing concrete and quarrying rock, etc., which is hard work. To use correctly, you should be a skilled operator of the carrier machine. Do not use or install the equipment until you can use the carrier machine. Please do not rush learning the job, take your time and learn safely. Hydraulic fluid at operation is dangerous. Before disconnecting or connecting hydraulic hoses, stop the carrier engine and release pressure trapped in the hoses, When leaving equipment, please put the equipment should be lowered and engine off.

5.操作守则Practice

如果您在没有任何练习的情况下进行不熟练的操作，您和其他人可能受到严重的伤害。

练习要在一个无人空旷的地方实施。如果您要操作您的功能，请确保您可以安全实施的。

If you carry out unfamiliar operations without practice, you and others can be seriously injured. Practice will do on a clean area, and keep other people out. If you perform new operation, be sure you can do them safely.

6.通讯设备Communications

无信号的情况下可能引起事故的发生。工地通常是嘈杂的，所以不要想仅仅依靠讲话来传达指令。如果您和其他人一起工作，确保他们理解知道您的手势。即使在离人群有点远的时候，也可以通过手势通知他们您想要做什么。

Poor communications can cause accidents. Work site is usually noisy, so do not rely on spoken commands. If you are working with other people, make sure they understand your hand signals. Keep people away, and inform them of what you will be doing.

7.工作环境Work site

在工作之前，检查搜索凹坑洼地和隐蔽的石头等。如果您是工作在路面附近，请把地下的公共设施标注出来，例如电缆，自来水管及天然气管道等。坡面和壕沟也都是危险的地方。

尽量不要工作在坡面和壕沟那些容易塌陷的地方。尽量不要工作在坡面和壕沟那些容易塌陷的地方。并且在危险的地方随时都有旁观者清楚的看到一切动向。

Before working, check for potholes, weak ground, hidden rocks etc., and mark the position of underground utilities such as electric cables, and water or gas pipes, etc, if you are be working on a road near to them. Banked material and trenches are dangerous area too.

8.安全网Safety barriers

在一些公共场所，或者当能见度降低时，就要在周围设置上安全网来阻止其他人进入。如果您没有安全网，您必须确保工作区域的安全。

In public places, or when your visibility is reduced, place barriers around the machine to keep people away. If there is no safety barriers, you must obtain the excavating working area to operate safely.

9.设备范围及状态Equipment limits and condition

不要超越机器的极限范围操作。如果您那样做它可能会损害，并且也是危险的。在不受许可的情况下不要去尝试提升机器的任何性能。不合格的产品可能会伤害您或者其他的人。不要操作不合格的或者是零部件缺失的产品。使用之前一定要确保所有的保修工作都已完成。并且遵守工作场地及设备的法律法规。请不要在反常的高温下工作并且使用组装完好的设备。

Never operate the equipment beyond its limits. If you do so, it can cause damage, and also be dangerous. And do not try to upgrade the attachment performance by unapproved modifications, Defective product can injure you or others. Do not operate an equipment which is defective and has any of missing parts. Make sure all maintenance procedures are completed before use. And obey all laws and regulations of the work place and equipment. Please do not operate at abnormal high temperature and use only completely assembled.

10.维修及保养Repairs and maintenance

在您不明白的情况下请不要做任何维修或者保养。当您需替换老化零件时，请您联系我们北奕公司的售后服务部咨询他们的意见。做维修和服务都要经授权的单位或个人来操作。在运输机械时请拆下我们的设备。最后检查安全之后，如果有必要就替换它。

我们的产品主要应用在重型挖掘机和建设工程方面。如您所知，工程状况总是危险的。因此您应该时刻警惕危险。很多死亡和受伤都源于不正确的操作，维修及保养。最终您有任何不理解的事情，建议您咨询我们的售后服务部。请勿不懂装懂。操作者可以做一些保养条例上允许的事情。

Do not try to do repairs or any other maintenance you do not understand. When you need to replace old part for new one, please contact your Beiyi service center for advice. Service and repairs are only to be made by authorized personnel. Please remove products from carrier during transport. Finally safety decals must be checked and if necessary replaced.

The products are suitable for major heavy excavators and construction work. As you know, the construction site is always dangerous, thus you should be alert for hazards. Death or serious injury results from improper use, repair or maintenance. Finally, if there is anything you do not understand, ask your Beiyi Service Center for advice. Never assume anything you do not understand. Operator may do only the permitted maintenances listed in the manual.

 **警告CAUTION**

带有旋转锁定操作的附属装置可以设置剪切臂以便垂直于目标物。不要使用剪刀来打击混凝土或推移东西。装置可能会受到损害。

For operating the attachment with the swivel locked, set the cutting arm so as to be perpendicular to the object. If any abnormal force is applied to the shear, the lock pin that serves as a safety device will be broken to protect the shear. Do not use the shear to hit at concrete, etc., or as a level. The crusher may be damaged.

 **警告CAUTION**

当轧碎和剪切臂被锁住时油缸抽杆是外露的。避开与混凝土铁定等接触。禁止将钢筋等插入轧碎臂等插入轧碎臂及油缸活塞杆装置之间。油缸活塞杆可能会受到损害。不要操作设置在挖斗油缸的剪切动臂。挖掘机的导向环等可能会受到损害。

不要剪切超过设备范围的钢铁材料。不要用设备的任何部位来剪切钢筋除了刀具部位。装置可能会受到损害。

When the crushing and cutting arm is locked, the cylinder rod is exposed. Avoid contact with any concrete blocks, iron bars, etc. Do not insert reinforced bars or etc between the crushing arm and the cylinder rod device. The cylinder rod may be damaged. Do not operate the cutting arm with the bucket cylinder set at the stroke end. The guide ring, etc. of the hydraulic excavator may be damaged. Do not cut steel materials beyond the capacity of the attachment. Do not cut iron bars, etc with any part other than cutter of the attachment. The attachment may be damaged.

 **警告CAUTION**

不要在超重范围的挖掘机使用。

当装置抓住臂时，小心不要让装置的末端对臂的底端或臂处的油缸干涉。当轧碎臂打开旋转功能时他可能会碰到驾驶室。一定要避免这个情况。

Do not operate the attachment with the weight of the hydraulic excavator applied to. Take care not to allow the end of the attachment to intervene with the boom bottom plate or boom cylinder when the attachment holds the arm. When the crushing arm of the attachment is rotated to be opened, it may come into contact with the cabin. Avoid it.

操作守则 Operation

1) 当油缸的抽杆到它的极限时，不能操作特殊设备。如果一个大力作用在全部延伸在外面的抽杆时，挖掘机的部件可能受到损害，弯曲，开裂。

1) Do not operate the BYCS Attachments when the excavator cylinder rods are extended to their ends of stroke. If a large force is exerted to the fully extended cylinder, the excavator links and other parts may be damaged, bent or cracked.



2) 不要使用北奕附属装置来做撬具，锤击或推移目标物。否则，装备会受到损害。

2) Do not use BYCS Attachments to pry, blow or pound objects. Otherwise, the shear and the excavator may be damaged.

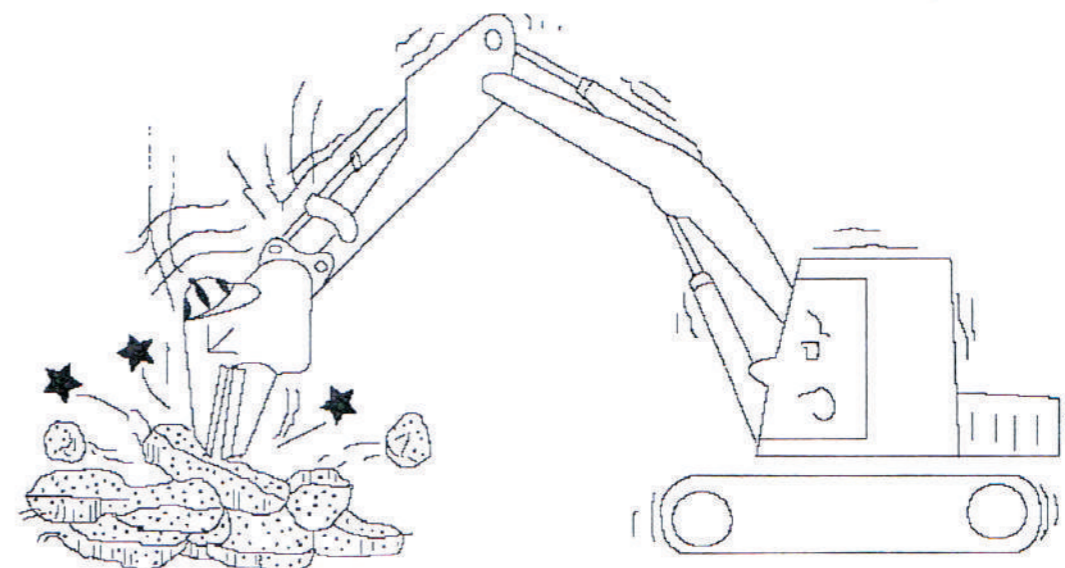

3) 当挖机行走的时候不要让特殊装备接触地面，否则过大的力应用在臂和销轴上会引起损害问题。

3) Do not press the BYCS attachments against the ground when the excavator turns around. Otherwise, excessive force is applied to the arm and pins, causing damage and problems.

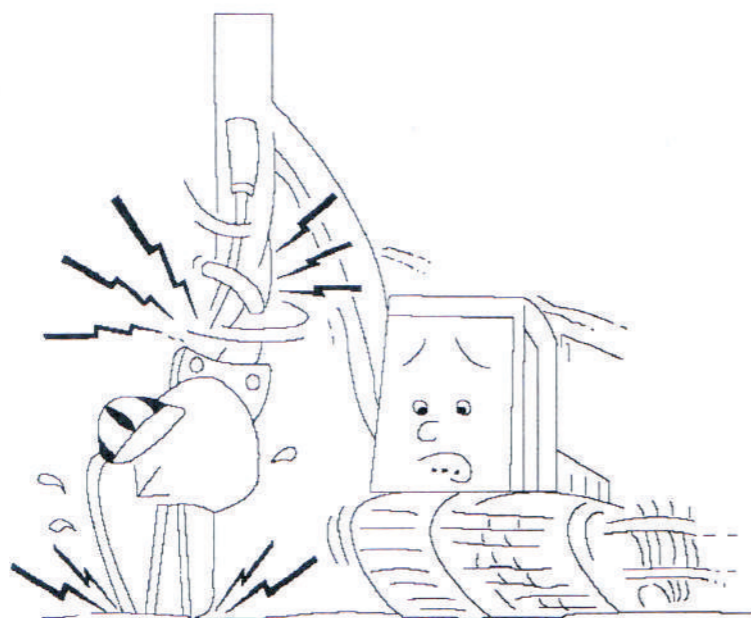

4) 请将挖掘机放在一个平坦的区域以便能平稳的站在那里。如果挖掘机倾斜，挖掘机的臂经受很大的力，这个臂可能会损害或开裂。

4) Place the hydraulic excavator on a flat area where it can stand stably and firmly. If the excavator is inclined, the excavator arm is subjected to excessive force and the arm may be cracked or twisted.

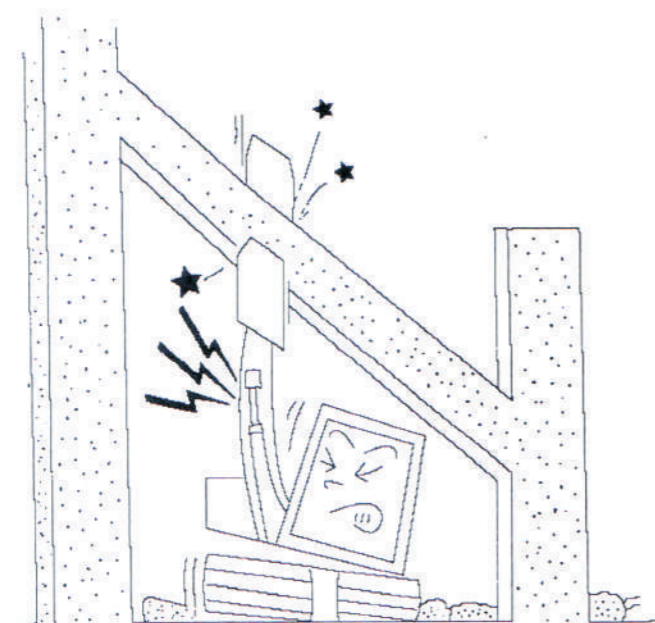

5) 不要使用特殊装置来挖平地，否则挖掘机经受额外的大力可能会损害。

5) Do not use the BYCS Attachments to flatten out rough ground. Otherwise, the excavator is subjected force and may be damaged.

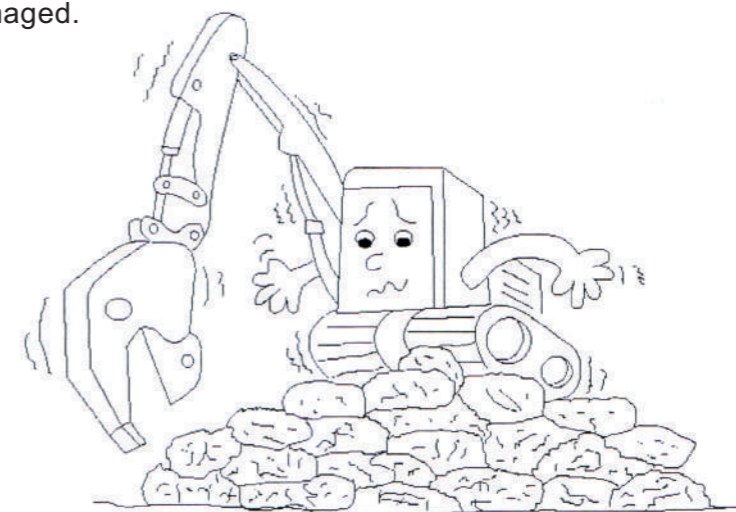

6) 不要用刀具的抽杆来推动混凝土块。

6) Do not bite concrete lumps with the reinforced rod cutter.

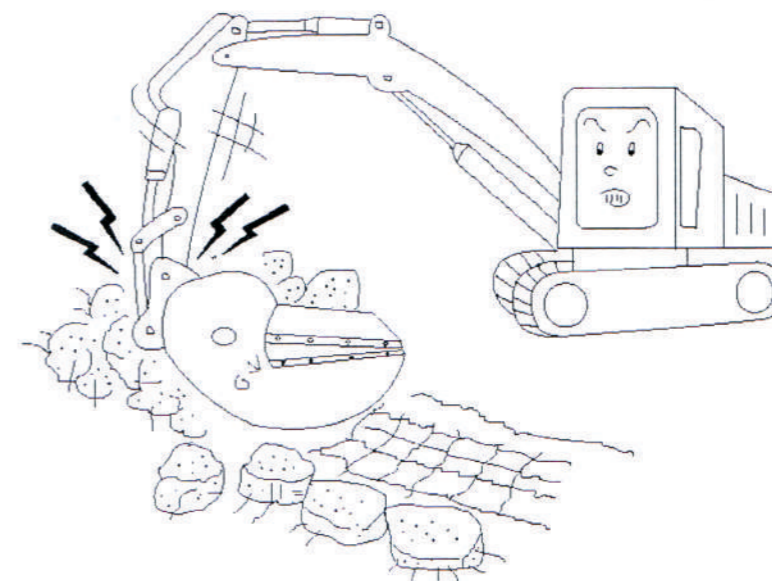

7) 当我们的装置抓住目标物的时候不要摆动或悬转。对于一些挖掘机臂的末端可能打开并释放目标物。这是很危险的。

8) 当挖掘机移动附属装置时，确保打开臂的末端。这样保护活塞杆免受伤害。

9) 当离开挖掘机时把附属装置放在地上并停止引擎。

7) Do not run or swing the excavator while the BYCS Attachments holds an object.

8) When the excavator travels with the BYCS Attachments, be sure to open the ends of the arms. This protects the piston rod against damage.

9) When leaving the excavator, put the BYCS Attachments on the ground and stop the engine.

操作警告 Caution



警告CAUTION

- 关闭驾驶室前面的网屏或碎片保护器来防止碎石伤害到司机。
- 如果噪音超过90分贝（A），每个在周围的人包括司机都必须带上口罩及护耳器。
- 我们的附属装置应该来自司机的操作，直到挖掘机和装置放好位置才能操作。
- 如果进入危险地带请立即停止使用附属装置因为操作附属装置遇到飞石的风险远大于挖掘机。当使用北奕附属装置驾驶时驾驶员要遵守制造商的安全守则。
- 只是用组装完全的附属装载确认所有的调节都是好的。
- 喝酒或服用药物的条件下都不能操作设备。
- 当从搬运设备上查下来做保养和维修时，确保将其放平稳，尽可能放低位置
- Close the front screen or splinter protection on the drivers cab to prevent possible injury from flying rock splinters during operation.
- If noise levels exceed 90dB(A), every person in the surrounding area, including the excavator driver must wear ear protector, and breathing protection.
- The hydraulic BYCS attachments should be operated from the driver's seat and should not be put into operation until both the excavator and attachments are in the right position.
- Stop the hydraulic BYCS attachments immediately if one goes into the dangerous areas, which is much larger for attachments operation than for excavator operation due to risk of flying rock .
- When working with a hydraulic BYCS attachments , operation of the excavators is governed by the excavator manufacturer's safety regulations.
- Make sure all the adjustments are properly made, and use only the completely assembled.

安装说明 Installation

5.1 操作之前的准备工作 Preparation before operation

- 1) 检查液压油的总量，如果有必要加满同等品牌的液压油。
- 2) 确保截止阀是完全打开的。
- 3) 操作之前，检查拧紧好所有的螺栓螺母。螺母螺栓送了之后会引起问题例如漏油，螺栓破裂和螺纹损伤。
- 4) 在使用之前，加注黄油在轴套和销轴之间，黄油一天注入多于两次。
- 5) 在设备没有载荷的情况下操作并检查有什么异常情况。同时检查是否漏油。
- 1) Check the amount of hydraulic oil. If necessary , replenish the hydraulic oil of the same brand.
- 2) Make sure that stop valves are fully opened.
- 3) Before the operation, check that all bolts and nuts are tight .Loose bolts and nuts may cause problems such as oil leakage, bolt breakage and screw thread damage.
- 4) Be sure to apply grease to pins and bushing before use. Greasing is needed more than two times a day.
- 5) Operate the shear series without load and check for any abnormalities. Also check for oil leakage.

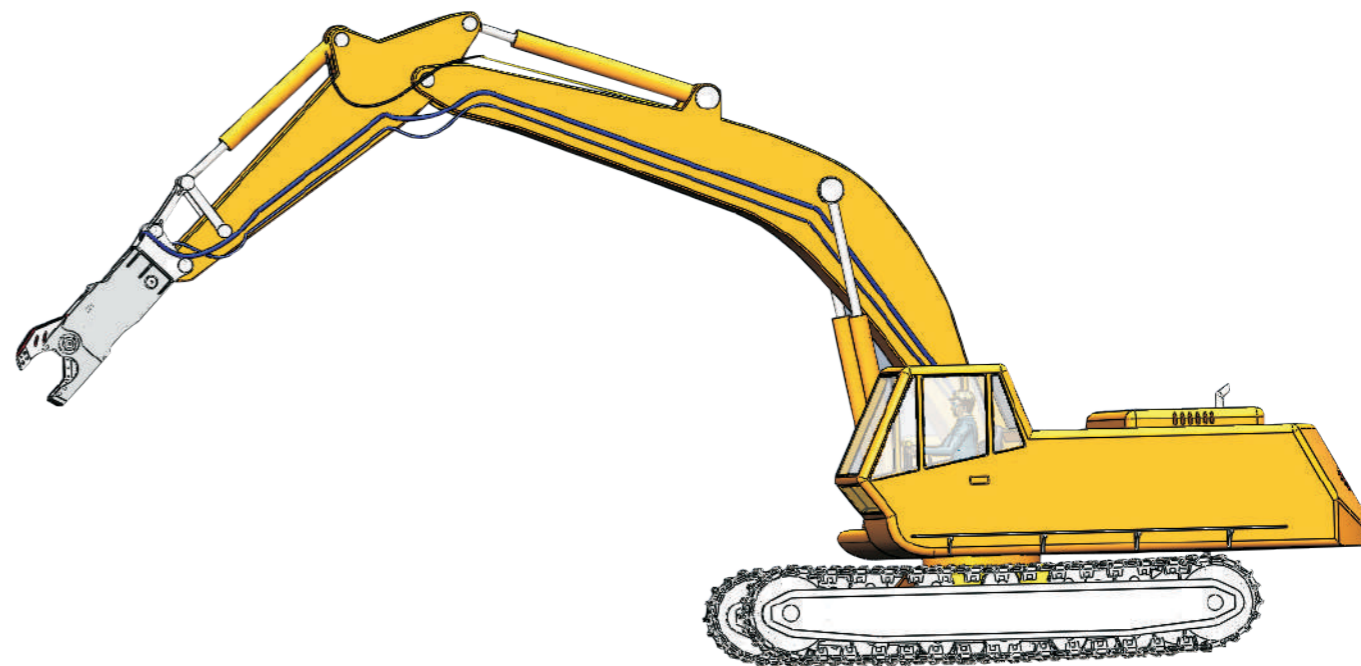

5.2 设置压力Set up Pressure

| 型号 Module | 总重量 Total Weight kg | 全长 Total Length mm | 最大开口宽度 Max opening width mm | 最大使用油压 Max oil pressure Mpa | 开口深度 Opening depth mm | 适配挖机重量 Hydraulic excavator T |
|--------------|---------------------------|--------------------------|-----------------------------------|-----------------------------------|-----------------------------|------------------------------------|
| BY-MTK150S | 2100 | 2690 | 520 | 32 | 420 | 15-20 |
| BY-MTK250S | 2600 | 3135 | 550 | 32 | 600 | 20-30 |
| BY-MTK300S | 2700 | 3184 | 860 | 32 | 486.5 | 20-30 |

最大额定压力不能超过32MPa,如压力过大导致油缸损坏不予以三包

Maximum rated pressure should not exceed 35MPa, if the cylinder is damaged due to high pressure, we do not provide warranty.

5.3 安装说明Installation

1. 请将附属装置放在地上的方形木头上。
2. 在关闭截止阀的状态下，测量一下油缸和马达的油压，各自的数值请参考第一章。当您需要调整油压时请咨询我们售后人员或专业挖掘机修理师傅。
3. 用两个外壳销轴来连接挖掘机并且拧紧止动环。在组装时请注意用手势告诉挖机司机来保持轴套与孔的平直度。
4. 打开截止阀的帽盖来连接在剪刀的软管上。同时油管里剩余的油会流出所以准备一个空的盒子来接留下的油。
5. 在有效的升温之后打开截止阀操作设备。
6. 假设是马达旋转式请为了很好的旋转设置好马达油量每分钟3-6rpm。
7. 如果带有快换接头系统，请按照挖掘机附属装置的一致的方法的快换接头厂家。
8. 请在完成了上面所有的以后填写交付报告并发给我们。
9. 拆卸装备的程序和安装的方法是相反的。
 - 1) Put the BEIYI Attachments on wooden square bars laid on the flat ground.
 - 2) In the condition of turning off stop valve of excavator, adjust setting pressure for cylinder line and motor line. Please refer to chapter 1 for specific values respective. When adjusting all kinds of pressure, please follow the advice by our A/S person or authorized personnel has made.
 - 3) Stick to the excavator with two-bracket pin, and fasten bolt and nut together with stop ring. During assembling, pay attention to keep the straightness of both bush and holes of excavator using hand signal.
 - 4) Open the union cap of stop valve and connect hoses of the shear. At this time, the oil residue in pipes is subject to flow out, so prepare an empty box to capture the flowing oil.
 - 5) Turn on the stop valve and operate crusher after warming it up efficiently.
 - 6) In case of motor type, please set the flow rate for motor in order to acquire proper revolution per minute, 3~6 rpm.
 - 7) If the excavator has quick coupler system, please stick BEIYI Attachments to excavator in accordance with installation method of quick coupler manufacturers.
 - 8) After completing all of the above, please fill in the delivery report and send it to us.
 - 9) When dismantling, the procedures are reversal of the method of assembly.

5.4 注意事项Matters needing attention

1. 切断钢筋

首先，打开剪子上颚，然后用剪切部位咬住目标物体并且操作设备。当切断钢筋时请保持动臂与物体平行以免造成扭伤。这种弯扭对动臂和主体都可能带来损伤。铁锭应该一次性被剪切。

2. 旋转式

旋转马达是用来旋转设备主体的。他的转向有顺时针和逆时针两种。如果旋转时压力超过极限，操作者就要预防损害了。

3. 工作范围

在他的动臂范围内您可以自由的工作。凭借操作铲斗斗杆和臂的同时来调整剪刀的正确位置。

4. 请在完成了上面所有步骤后填写交付报告并发给我们。

1) Crushing work

First, open the crushing arms, and then hold an object with tooth that is at the end of the crushing part and operate the crusher. When crushing the beams, keep the crushing arms in parallel with the object to keep crusher away from wrench.

This wrench causes damage to body and arms. The iron bar should cut in a straight line.

2) Swiveling

Motor Rotate Type. The type of motor is rotational and it rotates the body. It turns both clockwise and counterclockwise. If the pressure is beyond limits when rotating, a protector operates to prevent damage.

3) Work range

You can freely work within the range of the crusher arm. Operate the crusher at the correct position by operating the excavator boom and arm at the same time.

4) After completing all the steps above, please fill in a delivery report and e-mail to us.

检测及保养 Detection And Maintenance

6.1 替换刀具 Replacing the cutter blade

这个刀具有四个切刃口它能使用螺栓来替换。

1) 更换时间

刀具应该每两个月更换一次。

2) 使用反面规定，如果刀具的使用超过2R, 刀具使用反面用打磨机将使用过的一面打磨一下，装上刀具以便刀片可以与基座紧密连接。

3) 安装和调节 序号4-1显示的怎样去除帽盖螺丝来更换刀具。通过一起移动压块位置来调节刀具的位置。序号4-1显示了如何通过设置压块的数量来。添加新的刀具。暂时拧紧刀具然后用木头锤子敲紧来让刀具与基体紧密联合，最终拧紧刀具。调节两个刀具之间的间隙在0.5mm-1mm. 如果间隙在摩擦期间变宽使用上面的方法再次调节。

The cutter blade has four cutting edges. It can be replaced by screwing or unscrewing the bolts.

1) Replacement time

The cutter blade should be replaced at every 2 months.

2) Use at the reversed state

If one side of the cutter blade goes beyond 2R, use the cutter blade at the reversed state. Grind the used side with a grinder and attach the cutter blade so that the cutter may come into close contact with the cutter base.

3) Mounting and adjustment

Fig. 4-1 shows how to removes the cap screw for mounting the cutter blade.

The shim plates for adjusting the cutter blade position can be removed together with the cutter blade.

Fig.4-1 shows how to attach the new cutter blade by adjusting the number of shim plates to be set.

Tighten the cutter blade temporarily and then drive the blade with a wooden hammer so as to drive the blade to comes into close contact with the cutter base and tighten the blade finally. Adjust the gap between two cutter blades to 0.5mm-1mm. If the gap is widened due to wears, adjust it again in the above manner.

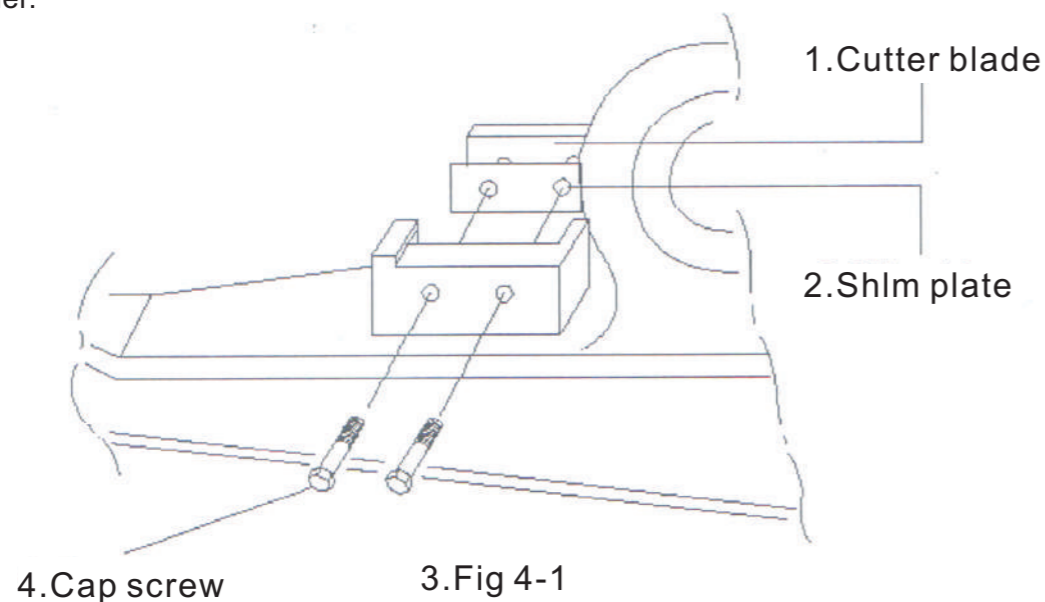

6.2 油管链接 Tubing connection

1. 将剪刀两端的软管分别与挖机头两端的管路口进行链接，拧紧螺帽。

2. 液压软管不允许急弯，不允许磨损，出现破损漏油应立即更换。

3. 在每次工作前应检查各个部件是否有漏油断裂等现象。

4. 拆卸装备的程序和安装的方法是相反的。

1. The hydraulic hose at the both ends of hydraulic pulverizer should be connected with the tube junction at both ends of the excavator head, tighten the nut.

2. Hydraulic hoses are not allowed to Sharp bends or wear, when broken or oil leakage, should be replaced immediately.

3. Before work, should check whether all parts are fracture or oil leakage.

4. The method is the opposite of disassembly procedures and installation.

产品细节 Detailed presentation



优质阀块

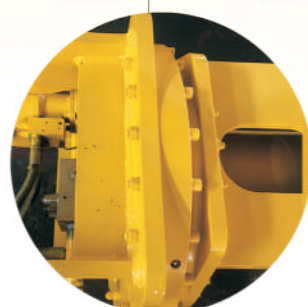

360°旋转



自产油缸



合金刀片

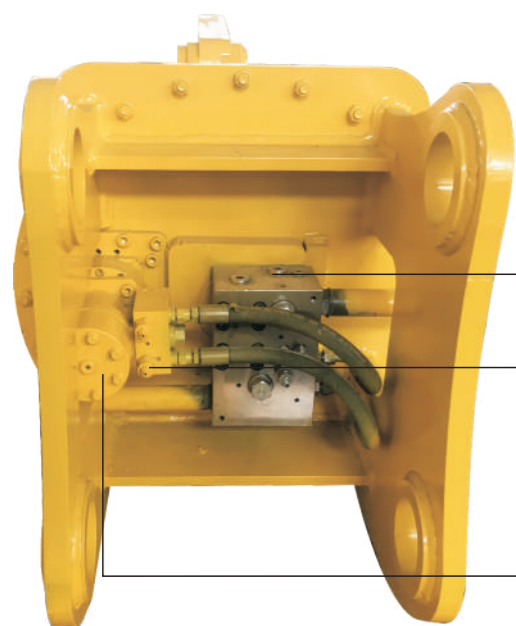

主阀

平衡阀

旋转马达

⚠️ 操作事项

- 1.大力神剪需客户挖机装有破碎锤管路接双向脚踏阀操作，
- 2.旋转单向360度旋转，张开到底才能旋转。
- 3.不需要电箱跟手柄操作"

尊敬的客户，感谢您在众多品牌中选择了北奕机械，为了您的设备使用更为方便安全，北奕机械特此为每一位客户都配有售后服务卡，如果您在使用北奕设备过程中遇到任何问题请拨打北奕售后热线或者添加北奕售后客服微信咨询，北奕机械真诚为您服务。

北奕机械
BEIYI MACHINERY

售后服务



24小时售后电话：
18900636693(微信同号)
座机：0510-85101123
技术部：18068352969

微信ID: wxbeiyi360

在线售后
质保无忧

售后保障 正品保障 消费保障 快速处理

售后服务





售后客服
微信扫一扫